



Trailer mounted lift
TM13T

Trailer mounted lift

TM13T







STANDARD EQUIPMENT

- Straight telescopic boom with moment control system
- 230V AC power source
- Wheel assist
- Autoplatfrom leveling with auto correction at 3°
- Chassis level sensor 1,5°
- Alu basket with wide tool tray, safety handrail and dual harness points
- Proportional electro-hydraulic controls by fingertip joysticks
- Ground pressure sensors on all outrigger plates with audible and visible alarms
- 230V outlet in the basket
- Hourmeter
- CE cert and EU road typ approval
- Ground and upper controls with tarp cover
- Manual recovery with hand pump
- Automatic reverse and overrun brakes
- Colour of the machine: RAL3002 (red)

OPTIONS

- Auto classic level
- Dual power source 230V & Honda
- Battery power 24V 225 Ah
- Custom colour
- G.R.P. basket with tool tray (2 person)
- Outrigger plate pads

SPECIFICATIONS

	TM 13T
	Working Height 13 m
	Platform Height 11 m
	Horizontal Reach (220kg) 7 m
	Horizontal Reach (100kg) 9 m
	Platform Capacity 220 kg
	Slewing 365°
	Platform dimensions 1.4x0.7x1.1 m
	Platform rotator 2x45°
	Transport length 5.95 m
	Transport width 1.58 m
	Transport height 1.99 m
	Total weight: (230V. wheel assist) ca. 1460 kg
	Total weight (230V. Honda. wheel assist) ca. 1495 kg
	Total weight (battery 24VDC. wheel assist) ca. 1580 kg
	Outrigger footprint ca. 3.72 m
	Outrigger plate outer edge
	Gradeability 6.8° (12%)
	Max. towing speed 80 km/h
	Brake Overrun Brakes with Gas Spring
	Tyres 195 R 14 C

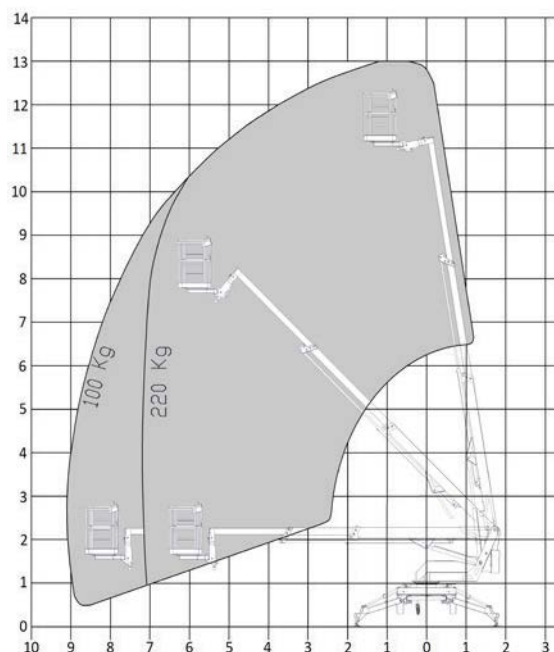
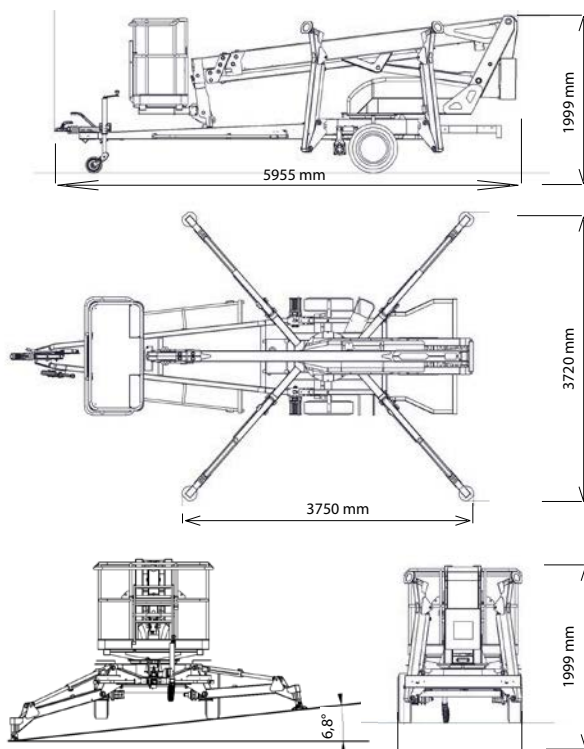

www.instant.no

INSTANT

Norway

Tel.: +47 23 19 11 00
info@instant.no

Lithuania

Tel.: +370 5 233 1096
info@instant.lt

Latvia

Tel.: +371 263 58 152
info@instantlatvija.lv

Estonia

Tel.: +372 680 76 33
info@instanteesti.ee